

Ultra Rapid Semiconductor Protection Fuse American Square Body Type Fuses

American Long Blades
Voltage Ratings 450V to 700V
Current Ratings 50A to 2500A
Sizes 0, 1, 2, 3



Key Features:

- ❖ 690V voltage rating complying with IEC, DIN and VDE standards
- ❖ Exceptionally low I^2t , power losses
- ❖ Non Magnetic construction, highly reliable low voltage indicator system
- ❖ Conform to UL, IEC, DIN and VDE standards
- ❖ Increased technical performance give higher ratings and a reduction in volume and weight
- ❖ All models with integrated trip-indicator
- ❖ Microswitch system reference MS 3V 1-5















Main Characteristics:

Size	Voltage U _N (V)	Ref:		Current rating I _N (A)	Pre-arcing I ² t @ 1 ms I ² t _p (kA ² s)	Total Clearing I ² t @ U _N (kA ² s)	Watt Losses 0.8I _N I _N		Tested Interrupting rating
0	700V	070US0D0063B		63	0.20	1.10	7.5	14	170kA @ 700V
		070US0D0080B		80	0.33	1.8	9.5	19	
		070US0D0100B		100	0.47	2.5	13	26	
		070US0D0125B		125	0.85	4.5	15	30	
		070US0D0160B		160	1.6	8.5	18.5	37	
		070US0D0200B		200	3	15.5	21.5	43	
		070US0D0250B		250	5.8	30	25	50	
		070US0D0315B		315	12	62	22.5	55	
		070US0D0350B		350	15.5	80	30	60	
		070US0D0400B		400	23	120	32.5	65	
		070US0D0450B		450	26	150	44	88	
		070US0D0500B		500	41	240	44	88	
		070US0D0550B	-	550	52	300	45	90	

















Notes: Minimum operating voltage for integrated trip indicator = 20V Microswitch reference: MS 3V 1-5

Size	Voltage U _N (V)	Ref:		Current rating I _N (A)	Pre-arcing I ² t @ 1 ms I ² t _p (kA ² s)	Total Clearing I ² t @ U _N (kA ² s)	Watt Losses 0.8I _N I _N		Tested Interrupting rating
1	700V	070US1D0200B		200	2.60	13.50	22.5	45	170kA / 700V
		070US1D0250B		250	4.70	25.00	25.5	52	
		070US1D0315B		315	7.50	40.00	32.5	65	
		070US1D0350B		350	10.50	55.00	33.5	67	
		070US1D0400B		400	19.00	100.00	34.0	68	
		070US1D0450B		450	26.50	140.00	35.0	70	
		070US1D0500B		500	37.00	195.00	36.0	72	
		070US1D0550B		550	52.00	280.00	37.5	75	
		070US1D0630B		630	75.00	390.00	42.5	85	
		070US1D0700B		700	95.00	490.00	42.5	95	
		070US1D0800B		800	140.00	800.00	60.0	120	

Notes: Minimum operating voltage for integrated trip indicator = 20V
Microswitch reference: MS 3V 1-5

Size	Voltage U _N (V)	Ref:		Current rating I _N (A)	Pre-arcing I ² t @ 1 ms I ² _p (kA ² s)	Total Clearing I ² t @ U _N (kA ² s)	Watt Losses		Tested Interrupting rating
							0.8I _N	I _N	
2	700V	070US2D0400B		400	15	80	32.5	75	170 kA / 700V
		070US2D0450B		450	22	115	40	80	
		070US2D0500B		500	28	145	45	90	
		070US2D0550B		550	37	195	47.5	95	
		070US2D0630B		630	54	280	52.5	105	
		070US2D0700B		700	76	400	55	110	
		070US2D0800B		800	115	600	60	120	
	690V +6%	070US2D0900B		900	170	900	62.5	125	200 kA / 700V
		070US2D1000B		1000	240	1250	67.5	135	
	650V	065US2D1100B		1100	270	1670	-	165	160kA @ 650V
	600V	060US2D1250B		1250	410	2400	-	180	150kA @ 600V
	550V	055US2D1400B		1400	555	3400	-	190	130kA @ 550V
		055US2D1600B		1600	870	5300	-	195	
	500V	050US2D1800B		1800	1050	8700	-	230	110kA @ 500V

Notes: Minimum operating voltage for integrated trip indicator = 20V Microswitch reference: MS 3V 1-5

Size	Voltage U _N (V)	Ref:		Current rating I _N (A)	Pre-arcing I ² t @ 1 ms I ² _p (kA ² s)	Total Clearing I ² t @ U _N (kA ² s)	Watt Losses		Tested Interrupting rating
							0.8I _N	I _N	
3	700V	070US3D0500B		500	19	100	52.5	105	170 kA / 750V
		070US3D0550B		550	27	140	55	110	
		070US3D0630B		630	40	210	60	120	
		070US3D0700B		700	55	300	62.5	125	
		070US3D0800B		800	95	490	65	130	
		070US3D0900B		900	135	700	67.5	135	
		070US3D1000B		1000	170	900	77.5	155	
		070US3D1100B		1100	240	1260	80	160	
	690V +6%	070US3D1250B		1250	350	1850	90	180	200 kA / 700V
		070US3D1400B		1400	480	2500	100	200	
	650V	065UR3D1600B		1600	555	3300	120	240	160kA @ 650V
		065UR3D1800B		1800	720	4450	-	260	
	600V	060UR3D2000B		2000	950	5600	-	290	130kA @ 600V
	550V	055UR3D2250B		2250	1250	7600	-	330	110kA @ 550V
	500V	050UR3D2500B		2500	1870	6540	-	330	110kA @ 500V

Notes: Minimum operating voltage for integrated trip indicator = 20V Microswitch reference: MS 3V 1-5

Electrical Characteristics:

Times vs current characteristics

The curves shown on page 4 indicate the pre-arcing time for each rated current as a function of RMS value of pre-arcing current I:

- Tolerances on this current ± 8%
- Beyond 30 sec or 10 sec, small overloads must be eliminated by another device.

Curve CC' represents the maximum times taken by the associated device to clear small overloads; only its horizontal line is represented.

Its oblique line must be plotted according to sketch in top right corner:

- The intersection of the fuse and CC' curves indicates the minimum breaking current I_{pm} of the fuse.

Size 0

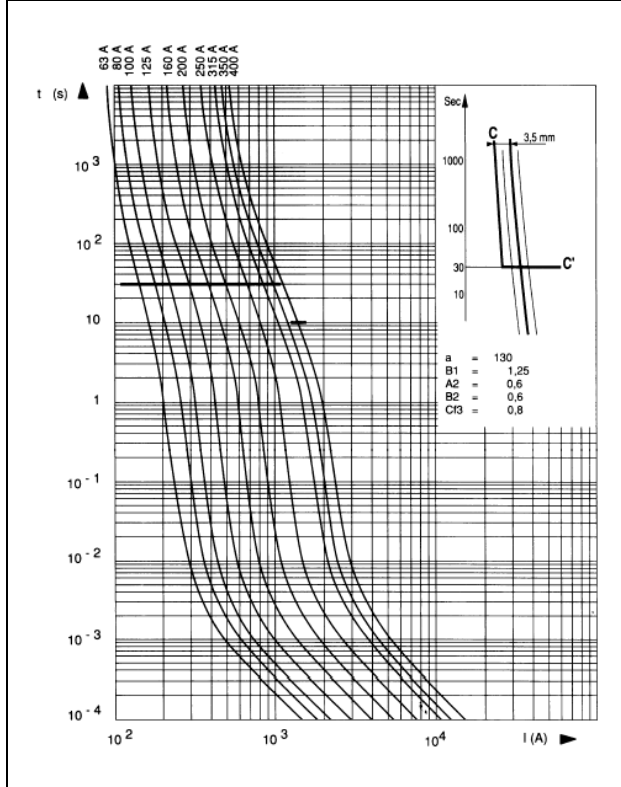

Size 1

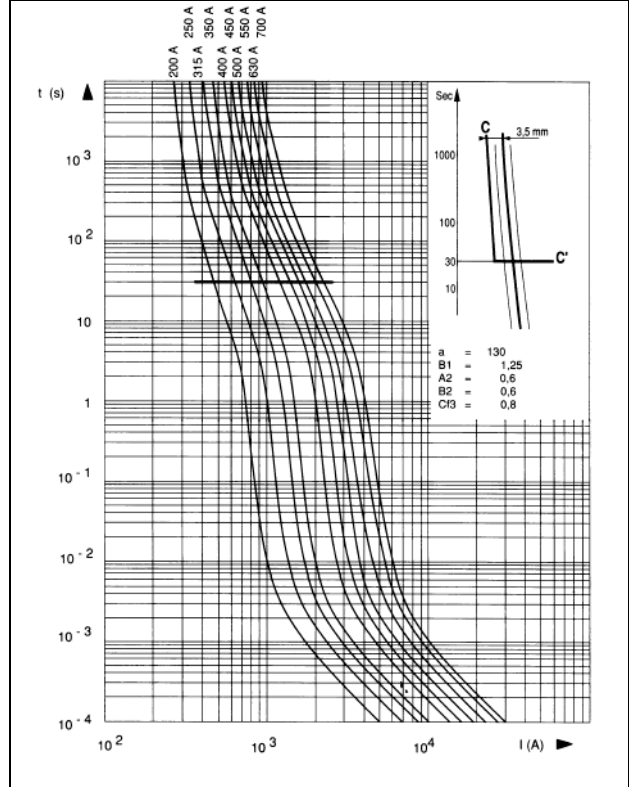

Size 2

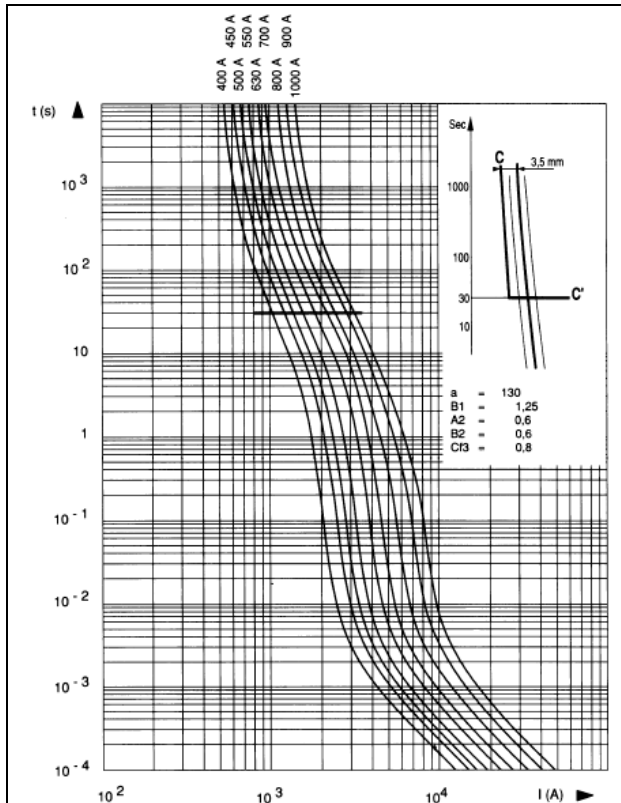

Size 3

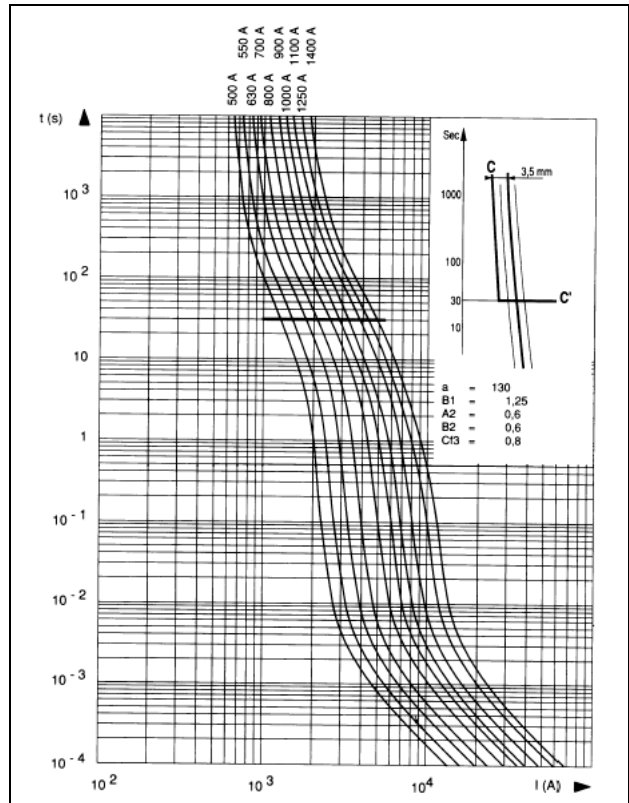

Total clearing I²T:

The horizontal curves given below indicated the maximum values of total operating I²t (I²t_t) as a function of prospective current I_p @ 660V, cosφ = 0.15. Oblique lines indicate the corresponding total operating time T_t, with pre-arcing time in brackets.

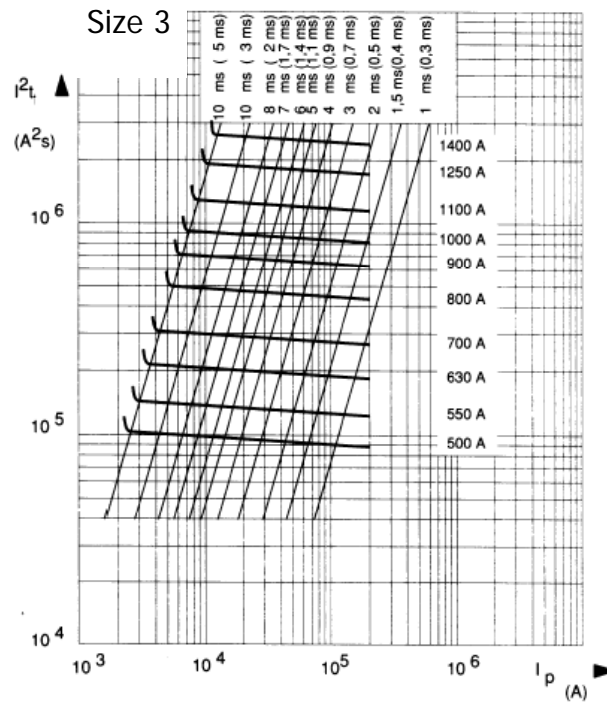
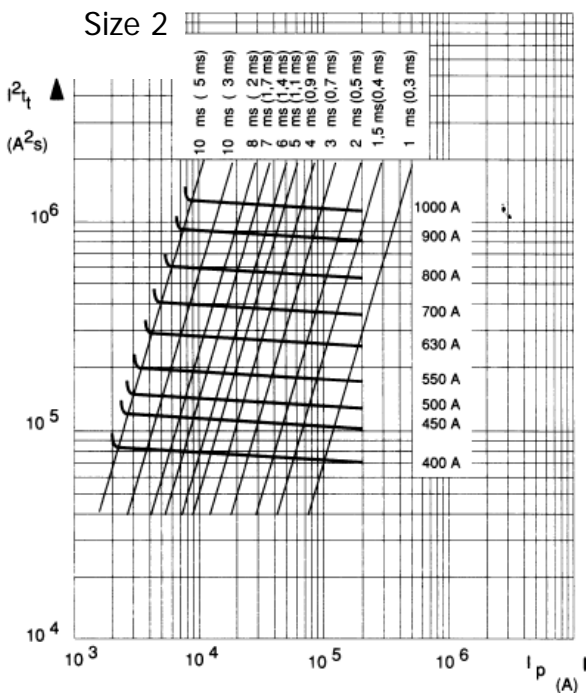
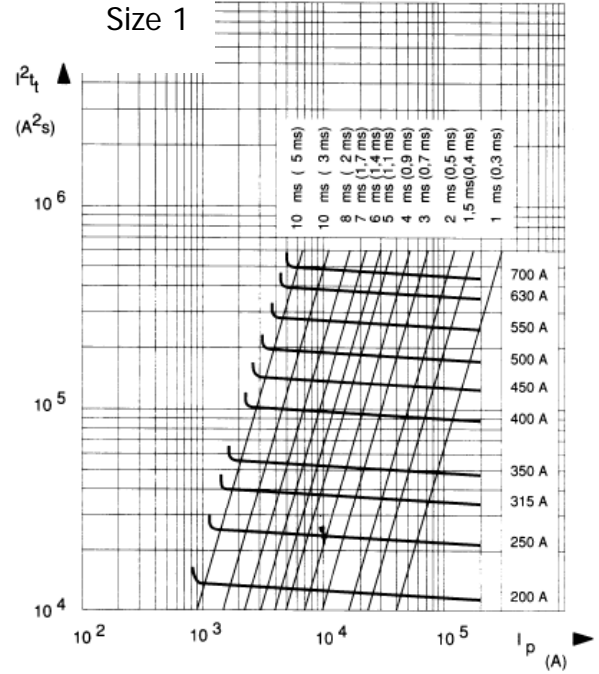
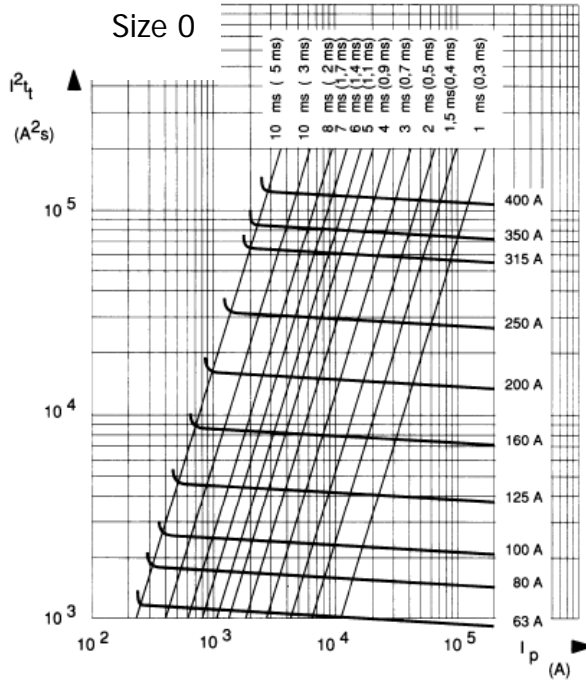

Cut off Characteristics:

The curves below indicate, for each rated current, the peak value I_c that the current may reach as a function of the prospective fault current I_p .

Size 0

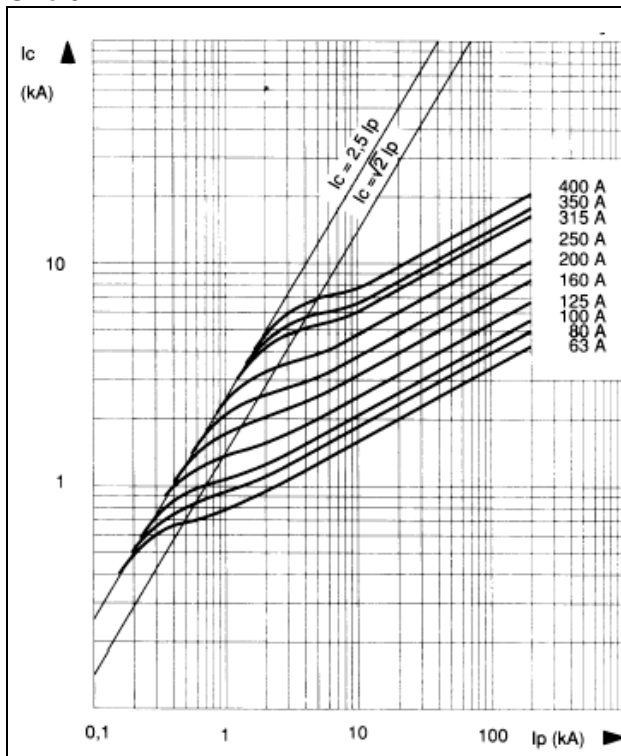

Size 1

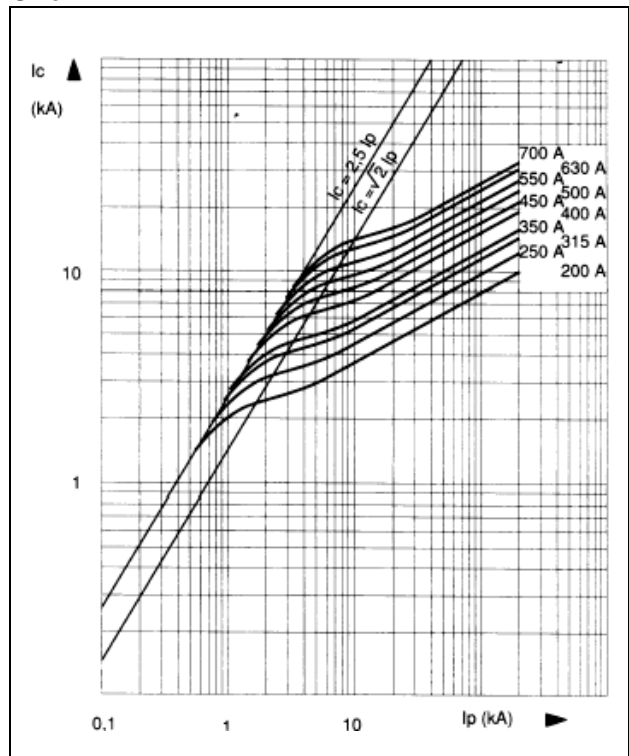

Size 2

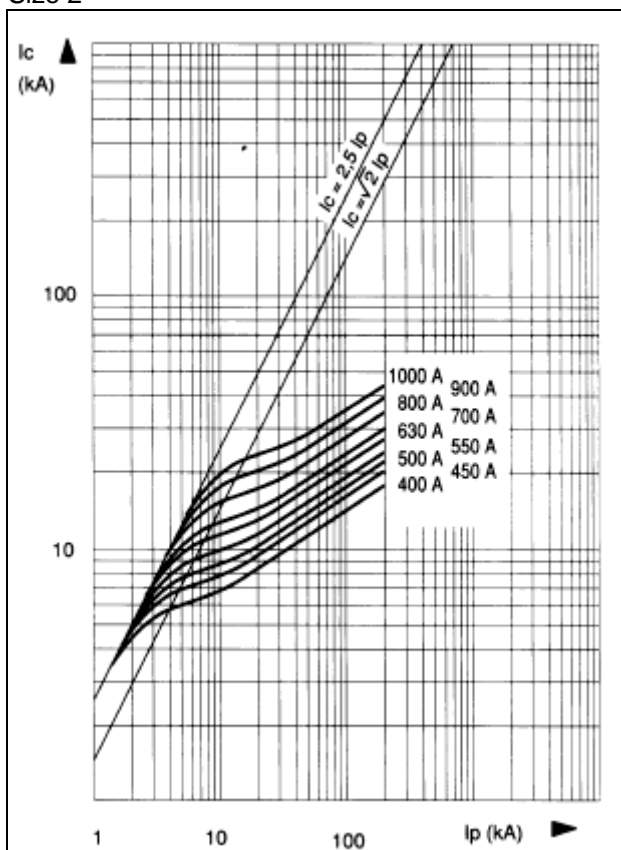

Size 3

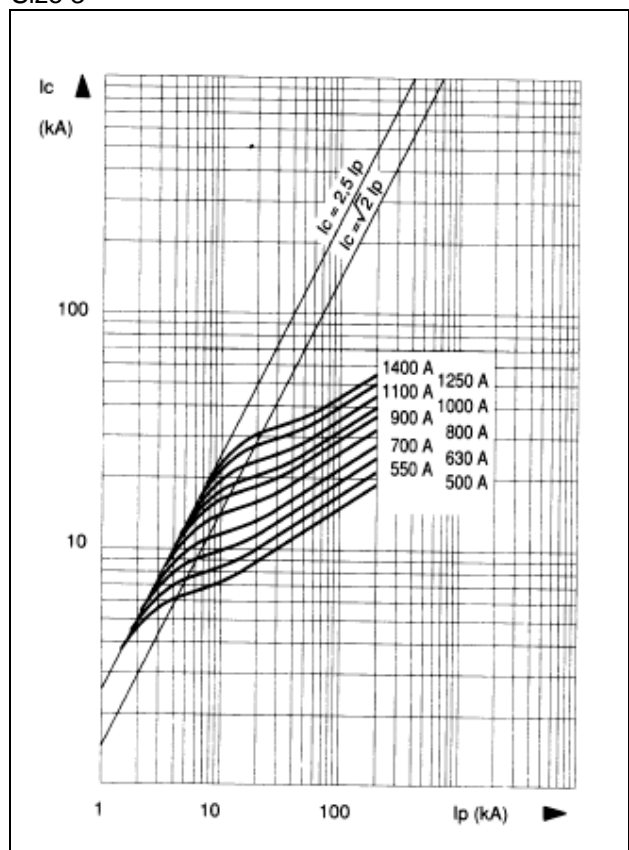

Corrective Factor – Peak Arc Voltage:

I^2t Multiplier Coefficient

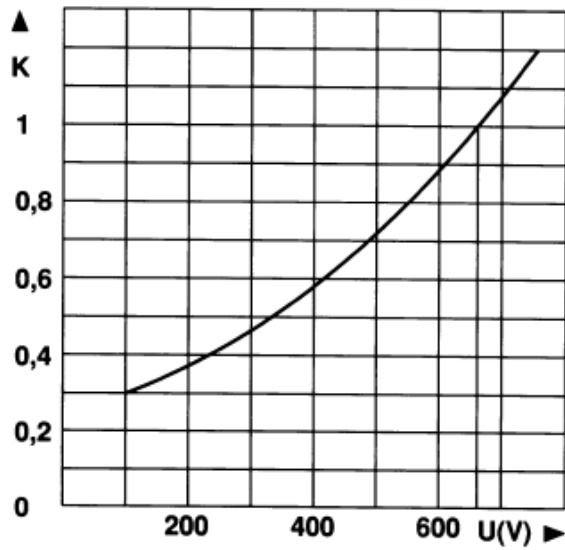

The above Mean curve shows variation of total clearing time (I^2t_i) and total operating time T_i in accordance with working voltage U.

Peak Arc Voltage

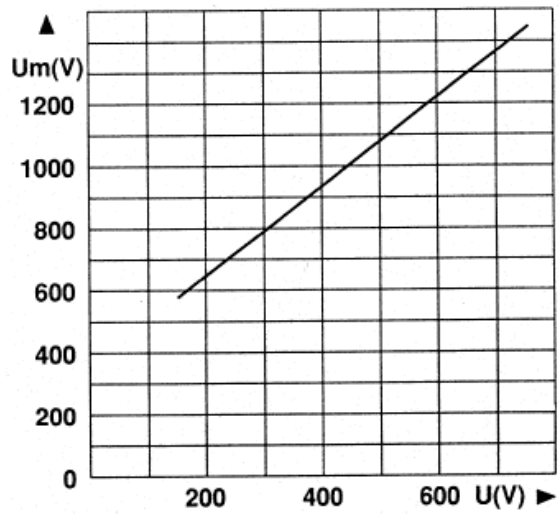

Curve indicating peak arc voltage U_m which may appear across fuse terminals as a function of working voltage U @ $\cos \varphi = 0.15$.

Dissipated Power

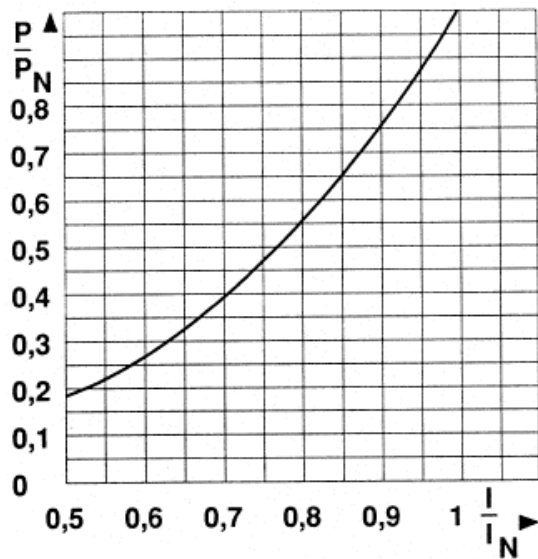

Curve enabling calculation of dissipated power P by a fuse rated I_N , as a function of the RMS current I, in multiples of I_N in a steady state.

Outline Drawing & Ordering Information:

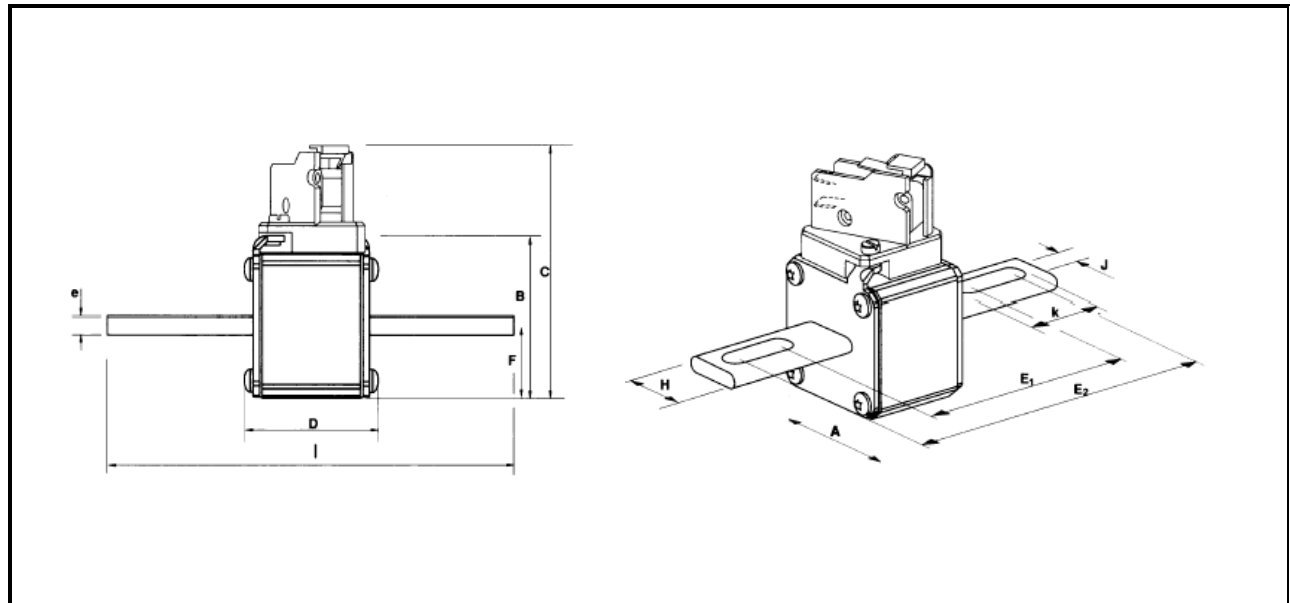

Dimensions (mm) (Imperial Measurements available upon request)

Size	A	B	C	D	E ₁	E ₂	F	H	J	K	L	E	Weight
0	40	46.5	82	47.5	87.6	126.6	21	25	105	30	148.5	6	290g
1	51	56.5	91	47.5	91.6	122.4	25.5	25	14.6	30	148.6	6	430g
2	60	65.5	100	47.5	94.2	129	30	32	14.6	32	153	6	590g / 660g
3	74.5	79.5	114	48.5	94.4	126.6	37.2	40	15.9	32	153	6	860g / 1070g

(*) size 2 from 900A and size 3 from 1250A

ORDERING INFORMATION

(Please quote code as below)

Voltage Rating (V)	Type	Size	Fixing	Current Rating Amps (A)	Indicator Type
700	US	0, 1, 2, or 3	D	0063 – 1600	B

Order code: eg. **070US3D0063B** = 700V, American Square Body Fuse with Long Blade, Size 3, 110mm fixing diameter, 63A with button indicator

IXYS Semiconductor GmbH
 Edisonstraße 15
 D-68623 Lampertheim
 Tel: +49 6206 503-0
 Fax: +49 6206 503-627
 E-mail: marcom@ixys.de



Westcode Semiconductors Ltd
 Langley Park Way Langley Park
 Chippenham Wiltshire SN15 1GE
 Tel: +44 (0)1249 444524
 Fax: +44 (0)1249 659448
 E-mail: WSL.sales@westcode.com

IXYS Corporation
 3540 Bassett Street
 Santa Clara CA 95054 USA
 Tel: +1 (408) 982 0700
 Fax: +1 (408) 496 0670
 E-mail: sales@ixys.com

www.westcode.com

www.ixys.com

Westcode Semiconductors Inc
 3270 Cherry Avenue
 Long Beach CA 90807 USA
 Tel: +1 (562) 595 6971
 Fax: +1 (562) 595 8182
 E-mail: WSI.sales@westcode.com

The information contained herein is confidential and is protected by Copyright. The information may not be used or disclosed except with the written permission of and in the manner permitted by the proprietors Westcode Semiconductors Ltd.

© Westcode Semiconductors Ltd.

In the interest of product improvement, Westcode reserves the right to change specifications at any time without prior notice.